

Spherical roller bearings, cylindrical and tapered bore

Principal dimensions			Basic load ratings		Speed ratings		Designation
d	D	B	dynamic C	static C0	Reference speed	Limiting speed	
mm			kN		r/min		
280	500	176	3425	4900	800	1100	* SKF Explorer bearing 23256 CCK/W33 *

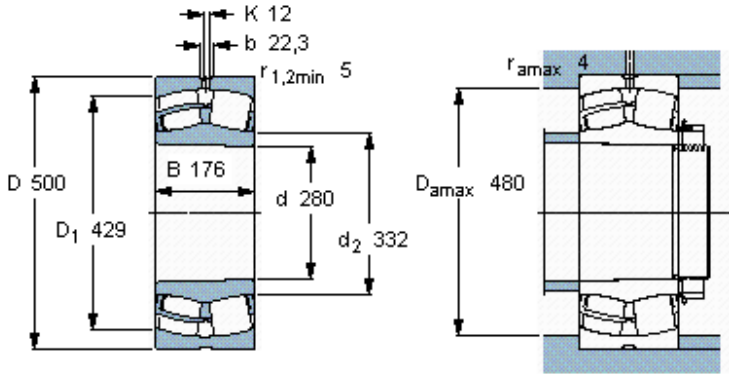

Tapered bore, taper
1: 12

Calculation factors

- e 0,35
- Y_1 1,9
- Y_2 2,9
- Y_0 1,8